



SCHAEFF

Warehousing
Series Lift Trucks

ELECTRIC
STAND-UP
COUNTERBALANCE



QUICK REFERENCE GUIDE

OPERATOR'S DISPLAY

SCHAEFF

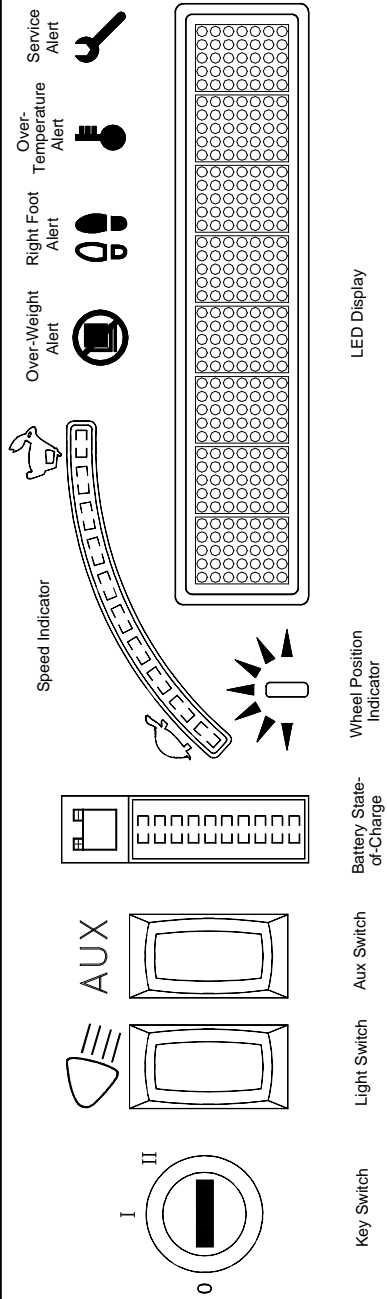

QUICK REFERENCE GUIDE



Electric
Stand-up
Counterbalance

Software Version 3.25
APPLIES TO VERSIONS 3.00 - 3.25
10/27/00

THIS REFERENCE GUIDE IS INTENDED AS A REPAIR AID ONLY. IT DOES NOT REPLACE THE SERVICE MANUAL. FOLLOW ALL INSTRUCTIONS AND PROCEDURES IN THE SERVICE MANUAL (68 400 03). FAILURE TO DO SO CAN RESULT IN PERSONAL INJURY AND PROPERTY DAMAGE.

All information, specifications, and illustrations in this manual are based on the latest available data at the time of publication. SCHAEFF is constantly striving to improve its products and, therefore, reserves the right to change design, materials, and/or specifications without notice and without incurring obligation or liability.

SCHAEFF and *each* are registered trademarks of Schaeff Inc.

PERFORMANCE & DIAGNOSTICS MENU

SOFTWARE VERSION 3.25

10/27/00

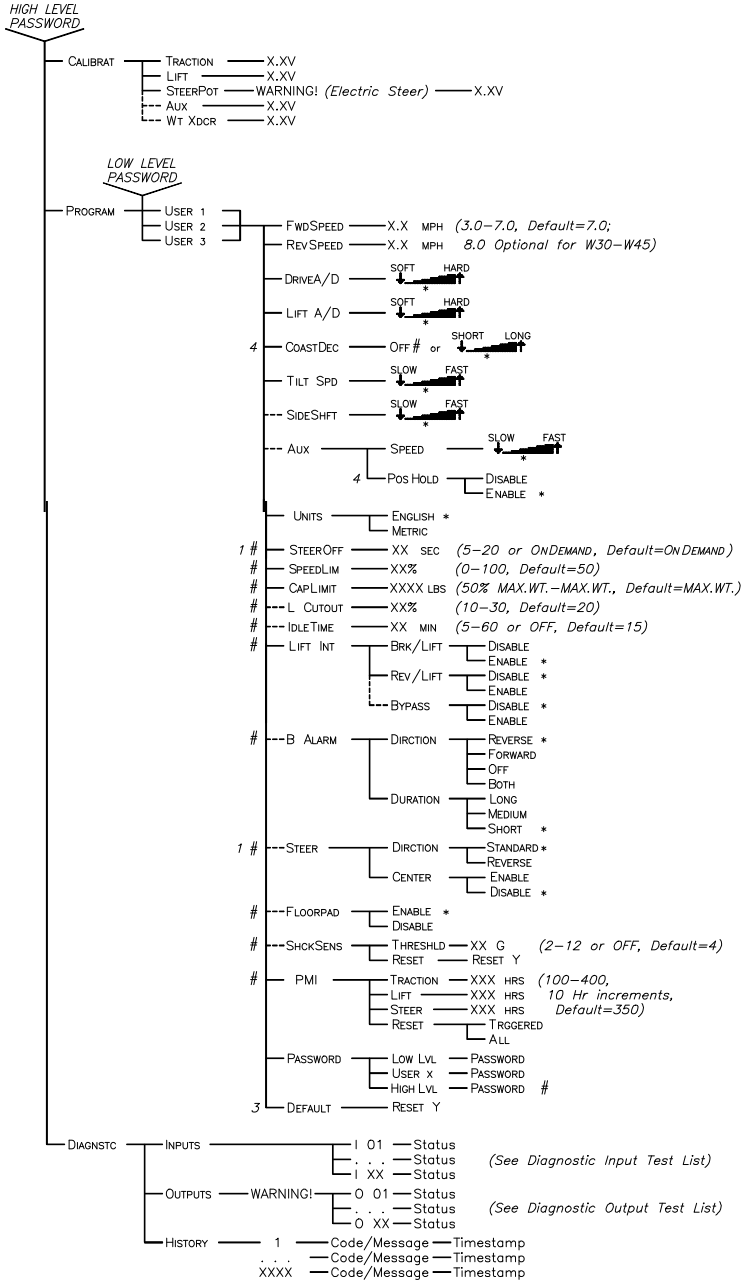

- * Indicates default selection
- Option: available when enabled
- # Indicates available only when High Level Password is entered
- 1 SteerOff for hydraulic steer only, Steer for electric steer only
- 2 Deutsch & French not available at time of publication
- 3 Default from Low Level resets only Low Level selections
- 4 CoastDec will not appear in Low Level Menu if set to OFF
- Pos Hold will not appear in Menu if CoastDec is set to OFF

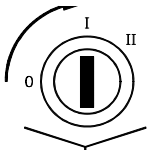

Pre-Operational Information

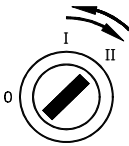
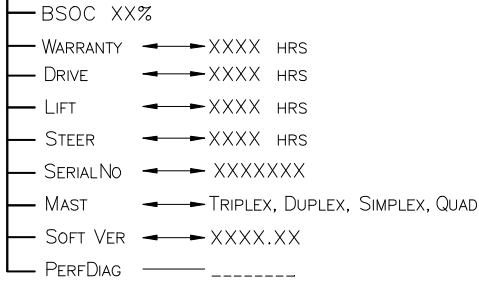

Operational Information

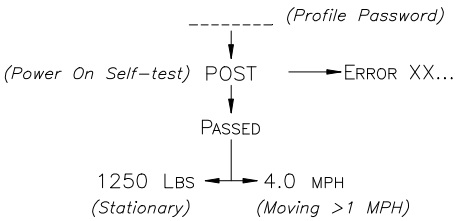

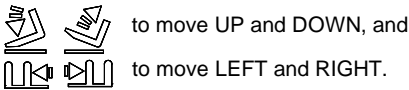

MENU CONVENTION

1. MOVE through the menu using:

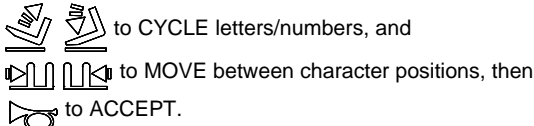

2. ENTER alphanumeric using:



3. SELECT options by pressing .





































DIAGNOSTIC MODE INPUT TESTS

TEST NO.	TEST NAME	FAULT DISPLAY
	NORMAL OPERATION DISPLAY	
I 01	Start Switch	
	I 01 - OFF (Pos I) or I 01 - ON (Pos II)	
I 02	Brake Limit Switch	17
	I 02 - UP or I 02 - DOWN	
I 03	Travel Potentiometer Voltage	06
	I 03 - VOLTAGE 3.1 - 4.6 Full Forks First 1.9 - 3.1 Neutral 0.4 - 1.9 Full Tractor First	
I 04	Lift/Lower Potentiometer Voltage	07
	I 04 - VOLTAGE 3.1 - 4.6 Full Lift 1.9 - 3.1 Neutral 0.4 - 1.9 Full Lower	
I 05	Steer Position Potentiometer Voltage	09
	I 05 - VOLTAGE 0.4 - 1.9 Full Left (-90°) 1.9 - 3.1 Straight (0°) 3.1 - 4.6 Full Right (90°)	
I 06	Auxiliary Multi-lever Potentiometer Voltage	08
	I 06 - VOLTAGE 3.1 - 4.6 Full Reverse 1.9 - 3.1 Neutral 0.4 - 1.9 Full Forward	
I 07	Tilt Limit Switch	18
	I 07 - OFF or I 07 - ON	
I 08	Lift Limit Switch	19
	I 08 - OFF or I 08 - ON	
I 09	Auxiliary Direction A Push Button	24
	I 09 - OUT or I 09 - IN	
I 10	Auxiliary Direction B Push Button	25
	I 10 - OUT or I 10 - IN	
I 11	Weight Pressure Transducer Voltage	10
	I 11 - VOLTAGE 0.5 - 4.5	
I 12	NOT USED (CG Transducer)	11
I 13	2nd Stage Sensor	
	I 13 - OFF (2nd) OR I 13 ON (1st)	
I 14	Floorpad Switch	16
	I14 - OFF or I14 - ON	
I 15	Electric Steer Encoder	91
	I 15 - NUMBER 000 - 255	

Some Input and Output tests shown will only be present in the menu list when the option is installed and enabled.

DIAGNOSTIC OUTPUT TESTS

**⚠ WARNING JACK THE TRUCK AND BLOCK THE WHEELS
BEFORE PERFORMING ANY MAINTENANCE OUTPUT TESTS**

O 01	Main Power Contactor	27A-F
	O 01 - OPEN   O 01 - CLSD	
O 02	Steer Motor	41A-D, 56, 59, 60
	O 02 - OPEN   XX AMPS	
O 03	Lower Solenoid	30A-D
	O 03 - OPEN   O 03 - CLSD	
O 04	Lift Solenoid	31A-D
	O 04 - OPEN   O 04 - CLSD	
O 05	NOT USED	
O 06	Tilt Forward Solenoid	33A-D
	O 06 - OPEN   O 06 - CLSD	
O 07	Tilt Back Solenoid	34A-D
	O 07 - OPEN   O 07 - CLSD	
O 08	Side Shift Left Solenoid	35A-D
	O 08 - OPEN   O 08 - CLSD	
O 09	Side Shift Right Solenoid	36A-D
	O 09 - OPEN   O 09 - CLSD	
O 10	Auxiliary Direction A Solenoid	37A-D
	O 10 - OPEN   O 10 - CLSD	
O 11	Auxiliary Direction B Solenoid	38A-D
	O 11 - OPEN   O11 - CLSD	
O 12	Impact Sensor	15, 47
	O 12 - X.XV   O 12 - X.XV	
O 13	Not Used	
O 14	Lift/Lower Proportional Solenoid	29A-D
	O 14 - OPEN   O 14 - CLSD	
O 15	Horn	26
	O 15 - OFF   O 15 - ON	
O 16	Display	
	O 16 - OFF   O 16 -	
O 17	Left Traction Motor	51L, 61-68L, 84L, 87L
	O 17 - OFF   Fxx/Axxx  x.xx MPH	
O 18	Right Traction Motor	51R, 61-68R, 84R, 87R
	O 18 - OFF   Fxx/Axxx  x.xx MPH	
O 19	Lift Motor	49, 57, 58, 88
	O 19 - OFF   xx.x AMP	

	COMPONENT	CHECK/ACTION	HOURS DAYS	8 1	40 5	350 60	2000 360	-40°F to 32°F	32°F to 120°F
1	Battery	Charge - Normal Charge - Equalizing Check water level and cleanliness Connector in good condition, bolt installed		X	X	X			
2	Battery Disconnect	Check for free movement of the lever and lever disconnects battery. Do Not Lubricate		X					
3	Battery Gates	Check that they are securely in place		X					
4	Battery Rollers	Do Not Lubricate Plastic Rollers							
5	Brakes	Released when pedal depressed and stops unit within specified distance when pedal released Brake pads - inspect and replace (as needed) Brake fluid - check level and add (as needed)		X		X	X	D	D
6	Brake Pedal/Linkage	Check for smooth operation, no binding, and pedal comes up when foot is removed. Do Not Lubricate		X					
7	Brake Switch	Locks out travel capability when pedal is up		X					
8	Carriage / Load Backrest / Forks	Inspect for cracks, bends, and damage Lubricate sideshift carriage		X	X			E	E
9	Contactors Tips	Check condition, inspect for pitting, adequate tip contact surface, signs of burning				X			
10	Control Handle	Check for smooth and full movement forward, reverse, lift, and lower, check horn, tilt, and all auxiliary functions for operation. Do Not Lubricate		X					
11	Decals	Check operational, safety, and warning decals. Replace if missing or unreadable		X					

12	Gearbox	Check operation Check fluid level and fill (as needed) Change fluid at first 100 hours, then:	X		X				C C C
13	Hydraulic System	Check for leaks Check level and fill (as needed) Change hydraulic oil and filter Breather cap - check and clean	X	X		X			B B A A
14	Lift Chains	Check for wear, damage, and cotter pins in place on connector pins at anchor bolts Lubricate and adjust		X		X			F G
15	Lights	Function when switched on	X						
16	Mast	Inspect for damage and Check for cotter pins in place on tilt cylinder pins	X						
17	Motor Brushes	Check for wear and proper seating. Replace as needed			X				
18	Steering	Turns without binding - no excess play	X						
19	Tires/ Wheels	Inspect tires for cracks, gouges, and wear Lubricate wheel and final drive pinion bearings Lubricate final drive gears	X						E E H H
20	Static Strap	In place and touches the floor	X						

LUBRICATION REFERENCE TABLE

A	Texaco 32 / Tellus 32 / Mobil DTE 24	E	Mobilith SHC 220 Synthetic Grease NLGI 2 or equivalent
B	McCollister Arctic Blue Hydraulic Oil 3028	F	SAE 20W Motor Oil
C	Mobil SHC 50 Synthetic Gear Lubricant or equivalent	G	SAE 40W Motor Oil
D	SAE J-1703 Brake Fluid DOT 3	H	Mobilith SHC 007 Synthetic Grease NLGI 00 or equivalent

The numbers in this drawing correspond to the numbers in the first column of the SCHEDULED MAINTENANCE & INSPECTION TABLE.

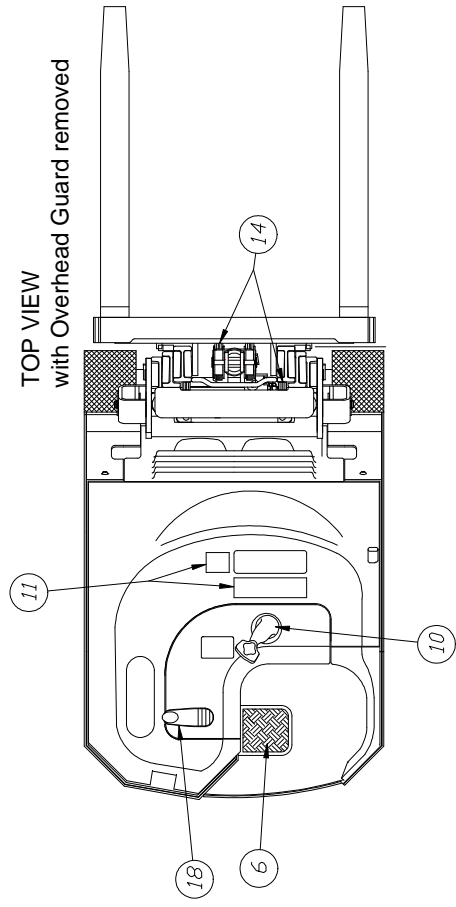
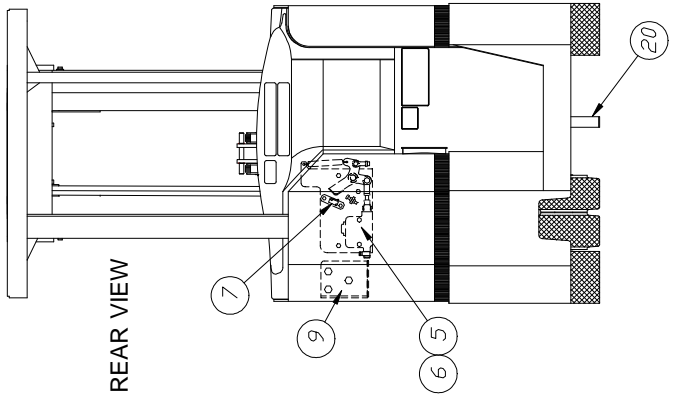

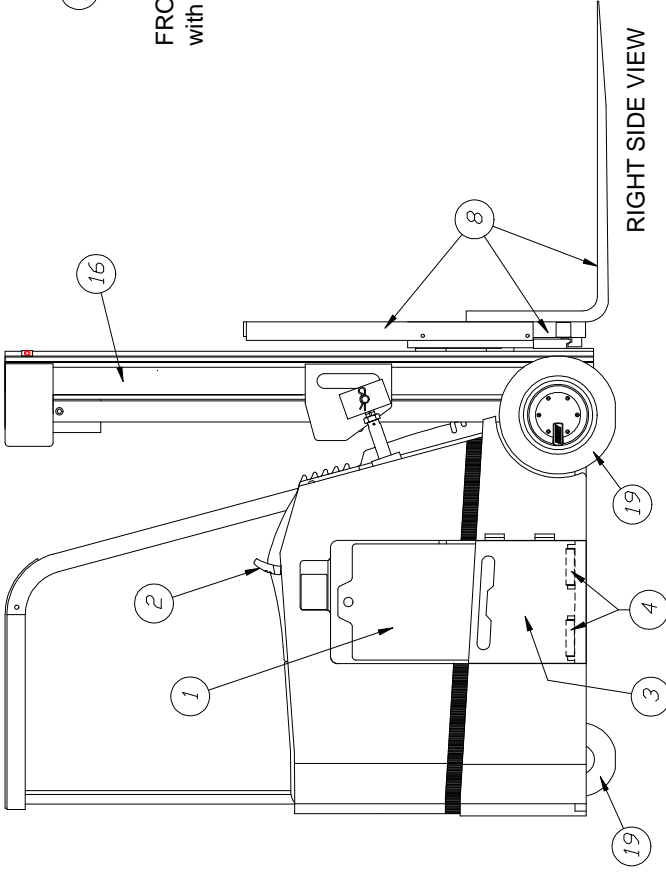
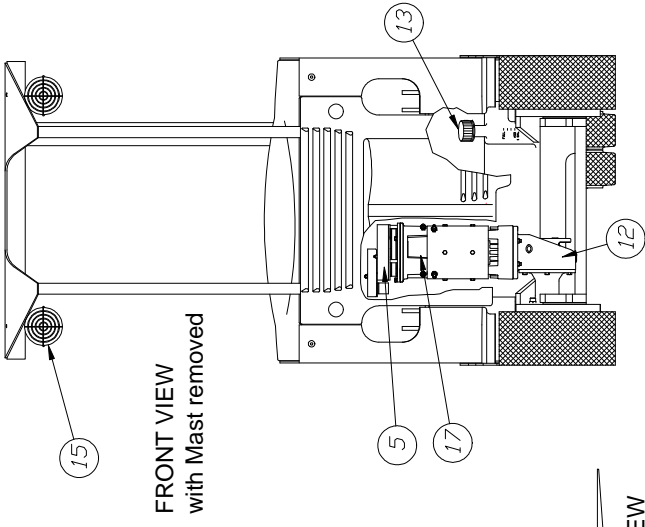

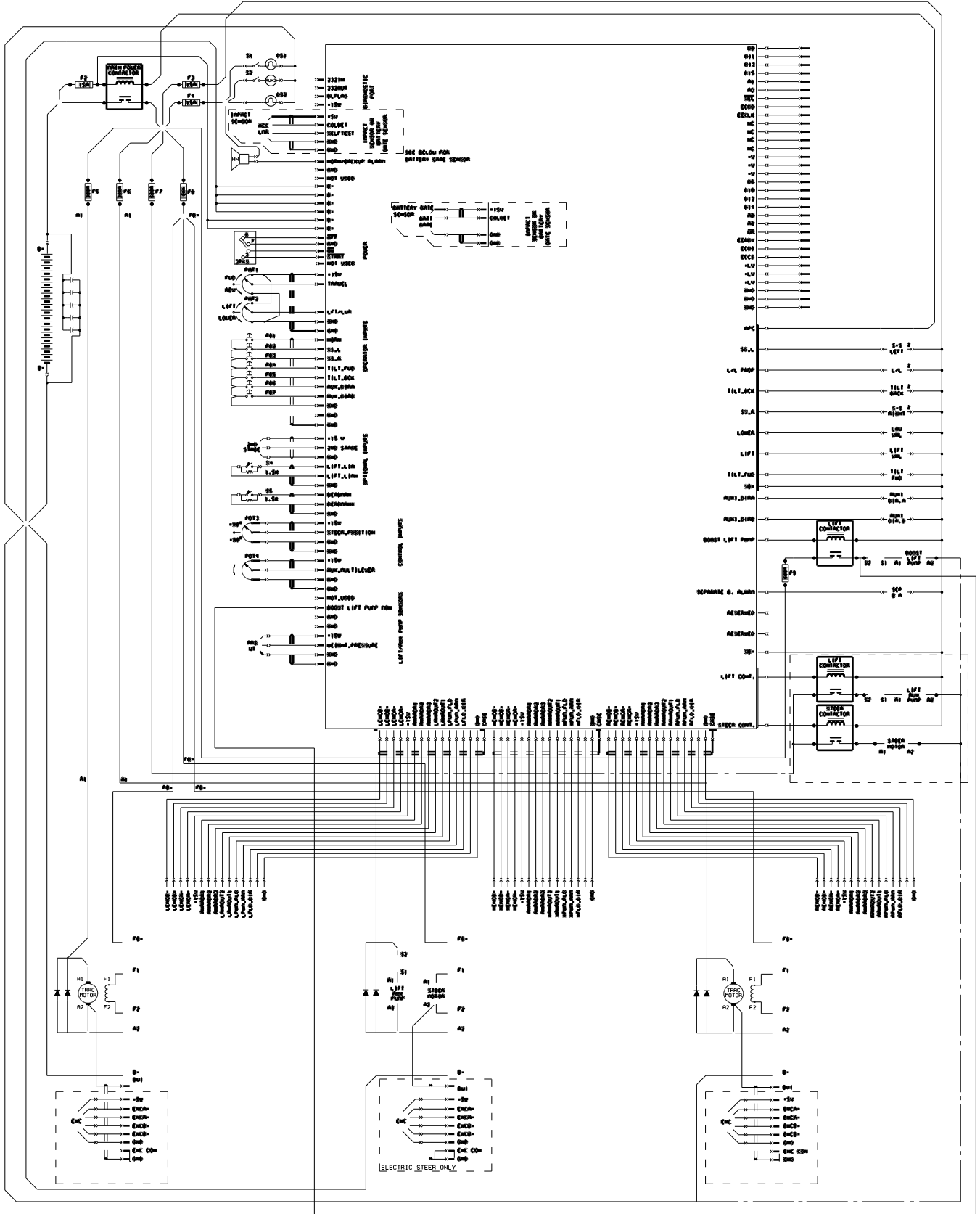

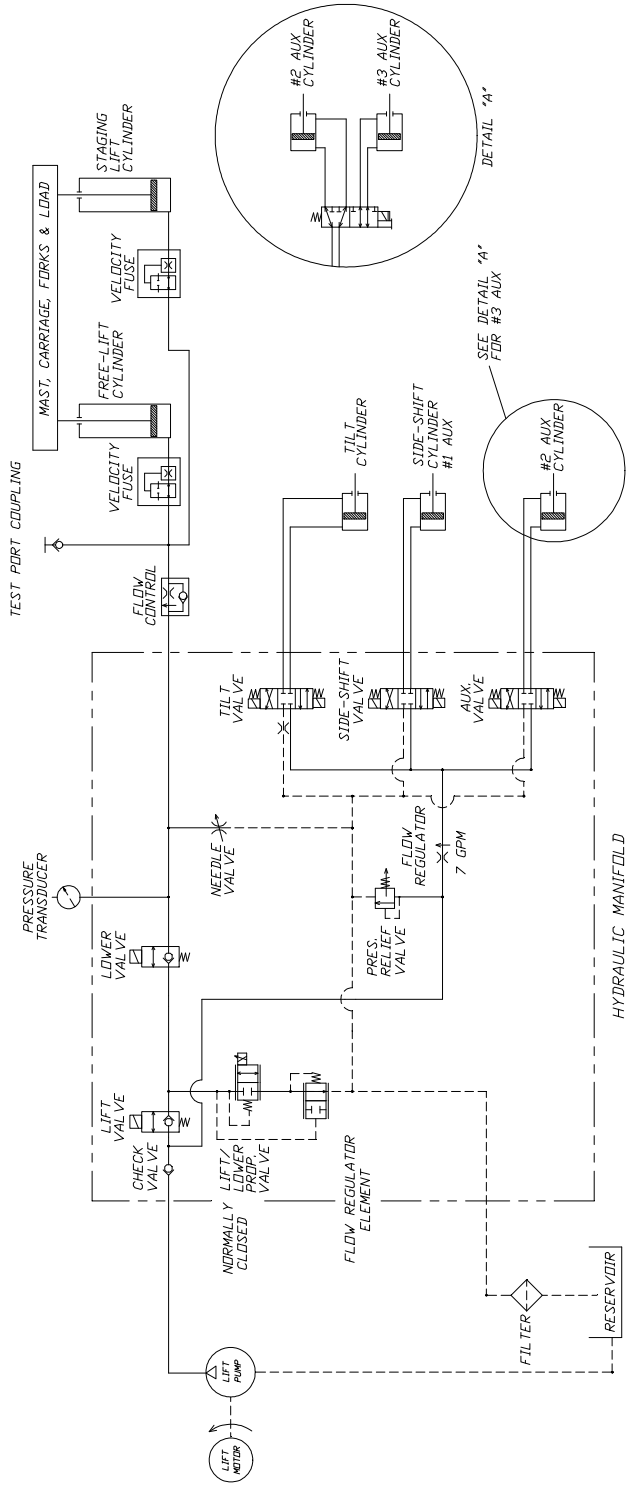

SYSTEM FAULT CODES (ERRORS)

ERROR NO.	FAULT CONDITION & DISPLAYED TEXT
	Resulting Effect
01	USER PROFILES INOPERABLE
	MESSAGE ONLY, at power-up
02	<i>Not used</i>
03	EXCEEDED WEIGHT LIMIT OF VEHICLE
	LIFT SYSTEM, except lower, and TRACTION shutdown until condition is cleared
04	<i>Not used</i>
05	BATTERY VOLTAGE OUT OF RANGE
	TOTAL shutdown
06	TRAVEL POTENTIOMETER VOLTAGE OUT OF RANGE
	TRACTION SYSTEM shutdown
07	LIFT/LOWER POTENTIOMETER VOLTAGE OUT OF RANGE
	LIFT SYSTEM shutdown
08	AUXILIARY MULTI-LEVER POTENTIOMETER VOLTAGE OUT OF RANGE
	LIFT SYSTEM shutdown
09	STEER POSITION POTENTIOMETER VOLTAGE OUT OF RANGE
	TRACTION SYSTEM shutdown
10	WEIGHT PRESSURE SENSE VOLTAGE OUT OF RANGE
	LIFT SYSTEM, except lower, shutdown
11	CENTER-OF-GRAVITY PRESSURE SENSE VOLTAGE OUT OF RANGE
	LIFT SYSTEM, except lower, shutdown
12	LIFT CONTROL TEMPERATURE SENSE VOLTAGE OUT OF RANGE
	LIFT SYSTEM, except lower, shutdown
13L/R	LEFT/RIGHT TRACTION CONTROL TEMPERATURE SENSE VOLTAGE OUT OF RANGE
	SPEED limited
14	LIFT MOTOR TEMPERATURE SENSE VOLTAGE OUT OF RANGE
	LIFT SYSTEM, except lower, shutdown
15	ACCELEROMETER VOLTAGE OUT OF RANGE
	LIFT and TRACTION SYSTEM deration
16	FLOORPAD SWITCH VOLTAGE OUT OF RANGE
	TRACTION SYSTEM shutdown
17	BRAKE PEDAL SWITCH FAILURE
	TOTAL shutdown
18	TILT LIMIT SWITCH FAILURE
	LIFT SYSTEM shutdown
19	LIFT LIMIT SWITCH FAILURE
	LIFT SYSTEM shutdown
20	SIDE SHIFT RIGHT SWITCH VOLTAGE OUT OF RANGE
	LIFT SYSTEM shutdown

SYSTEM FAULT CODES (ERRORS)

ERROR NO.	FAULT CONDITION & DISPLAYED TEXT
	Resulting Effect
21	SIDE-SHIFT LEFT SWITCH VOLTAGE OUT OF RANGE
	LIFT SYSTEM shutdown
22	TILT FORWARD SWITCH VOLTAGE OUT OF RANGE
	LIFT SYSTEM shutdown
23	TILT BACK SWITCH VOLTAGE OUT OF RANGE
	LIFT SYSTEM shutdown
24	AUXILIARY DIRECTION A SWITCH VOLTAGE OUT OF RANGE
	LIFT SYSTEM shutdown
25	AUXILIARY DIRECTION B SWITCH VOLTAGE OUT OF RANGE
	LIFT SYSTEM shutdown
26	HORN SWITCH VOLTAGE OUT OF RANGE
	DISPLAY MESSAGE
27A	MAIN POWER CONTACTOR DRIVER OVERHEATED
	TOTAL shutdown, until condition is cleared
27B	MAIN POWER CONTACTOR SHORTED TO SUPPLY
	TOTAL shutdown
27C	MAIN POWER CONTACTOR SHORTED TO GROUND
	TOTAL shutdown
27D	MAIN POWER CONTACTOR DISCONNECTED
	TOTAL shutdown, until condition is cleared
27E	MAIN POWER CONTACTOR WELDED
	TOTAL shutdown
27F	MAIN POWER CONTACTOR OPEN
	TOTAL shutdown
28	<i>Not Used</i>
29A	LIFT/LOWER PROPORTIONAL VALVE SOLENOID DRIVER OVERHEATED
	LIFT SYSTEM shutdown, until condition is cleared
29B	LIFT/LOWER PROPORTIONAL VALVE SOLENOID SHORTED TO SUPPLY
	LIFT SYSTEM shutdown
29C	LIFT/LOWER PROPORTIONAL VALVE SOLENOID SHORTED TO GROUND
	LIFT SYSTEM shutdown
29D	LIFT/LOWER PROPORTIONAL VALVE SOLENOID DISCONNECTED
	LIFT SYSTEM shutdown, until condition is cleared
30A	LOWER VALVE SOLENOID DRIVER OVERHEATED
	LIFT SYSTEM shutdown, until condition is cleared
30B	LOWER VALVE SOLENOID SHORTED TO SUPPLY
	LIFT SYSTEM shutdown
30C	LOWER VALVE SOLENOID SHORTED TO GROUND
	LIFT SYSTEM shutdown

SYSTEM FAULT CODES (ERRORS)

ERROR NO.	FAULT CONDITION & DISPLAYED TEXT
	Resulting Effect
30D	LOWER VALVE SOLENOID DISCONNECTED
	LIFT SYSTEM shutdown, until condition is cleared
31A	LIFT VALVE SOLENOID DRIVER OVERHEATED
	LIFT SYSTEM, except lower, shutdown, until cond. clear
31B	LIFT VALVE SOLENOID SHORTED TO SUPPLY
	LIFT SYSTEM, except lower, shutdown
31C	LIFT VALVE SOLENOID SHORTED TO GROUND
	LIFT SYSTEM, except lower, shutdown
31D	LIFT VALVE SOLENOID DISCONNECTED
	LIFT SYSTEM, except lower, shutdown, until cond. clear
32	<i>Not Used</i>
33A	TILT FORWARD VALVE SOLENOID DRIVER OVERHEATED
	LIFT SYSTEM, except lower, shutdown, until cond. clear
33B	TILT FORWARD VALVE SOLENOID SHORTED TO SUPPLY
	LIFT SYSTEM, except lower, shutdown
33C	TILT FORWARD VALVE SOLENOID SHORTED TO GROUND
	LIFT SYSTEM, except lower, shutdown
33D	TILT FORWARD VALVE SOLENOID DISCONNECTED
	LIFT SYSTEM, except lower, shutdown, until cond. clear
34A	TILT BACK VALVE SOLENOID DRIVER OVERHEATED
	LIFT SYSTEM, except lower, shutdown, until cond. clear
34B	TILT BACK VALVE SOLENOID SHORTED TO SUPPLY
	LIFT SYSTEM, except lower, shutdown
34C	TILT BACK VALVE SOLENOID SHORTED TO GROUND
	LIFT SYSTEM, except lower, shutdown
34D	TILT BACK VALVE SOLENOID DISCONNECTED
	LIFT SYSTEM, except lower, shutdown, until cond. clear
35A	SIDE SHIFT LEFT VALVE SOLENOID DRIVER OVERHEATED
	LIFT SYSTEM, except lower, shutdown, until cond. clear
35B	SIDE SHIFT LEFT VALVE SOLENOID SHORTED TO SUPPLY
	LIFT SYSTEM, except lower, shutdown
35C	SIDE SHIFT LEFT VALVE SOLENOID SHORTED TO GROUND
	LIFT SYSTEM, except lower, shutdown
35D	SIDE SHIFT LEFT VALVE SOLENOID DISCONNECTED
	LIFT SYSTEM, except lower, shutdown. until cond. clear
36A	SIDE SHIFT RIGHT VALVE SOLENOID DRIVER OVERHEATED
	LIFT SYSTEM, except lower, shutdown, until cond. clear
36B	SIDE SHIFT RIGHT VALVE SOLENOID SHORTED TO SUPPLY
	LIFT SYSTEM, except lower, shutdown

SYSTEM FAULT CODES (ERRORS)

ERROR NO.	FAULT CONDITION & DISPLAYED TEXT
	Resulting Effect
36C	SIDE SHIFT RIGHT VALVE SOLENOID SHORTED TO GROUND
	LIFT SYSTEM, except lower, shutdown
36D	SIDE SHIFT RIGHT VALVE SOLENOID DISCONNECTED
	LIFT SYSTEM, except lower, shutdown, until cond. clear
37A	AUXILIARY DIRECTION A VALVE SOLENOID DRIVER OVERHEATED
	LIFT SYSTEM, except lower, shutdown, until cond. clear
37B	AUXILIARY DIRECTION A VALVE SOLENOID SHORTED TO SUPPLY
	LIFT SYSTEM, except lower, shutdown
37C	AUXILIARY DIRECTION A VALVE SOLENOID SHORTED TO GROUND
	LIFT SYSTEM, except lower, shutdown
37D	AUXILIARY DIRECTION A VALVE SOLENOID DISCONNECTED
	LIFT SYSTEM, except lower, shutdown, until cond. clear
38A	AUXILIARY DIRECTION B VALVE SOLENOID DRIVER OVERHEATED
	LIFT SYSTEM, except lower, shutdown, until cond. clear
38B	AUXILIARY DIRECTION B VALVE SOLENOID SHORTED TO SUPPLY
	LIFT SYSTEM, except lower, shutdown
38C	AUXILIARY DIRECTION B VALVE SOLENOID SHORTED TO GROUND
	LIFT SYSTEM, except lower, shutdown
38D	AUXILIARY DIRECTION B VALVE SOLENOID DISCONNECTED
	LIFT SYSTEM, except lower, shutdown, until cond. clear
39A	BACKUP ALARM DRIVER OVERHEATED
	DISPLAY MESSAGE, until condition is cleared
39B	BACKUP ALARM SHORTED TO SUPPLY
	DISPLAY MESSAGE
39C	BACKUP ALARM SHORTED TO GROUND
	DISPLAY MESSAGE
39D	BACKUP ALARM DISCONNECTED
	DISPLAY MESSAGE, until condition is cleared
40	COIL DRIVER HARDWARE FAILURE
	TOTAL shutdown
41A	W2X STEER SOLENOID DRIVER OVERHEATED
	TRACTION SYSTEM shutdown, until cond. is cleared
41B	W2X STEER SOLENOID SHORTED TO SUPPLY
	TRACTION SYSTEM shutdown
41C	W2X STEER SOLENOID SHORTED TO GROUND
	TRACTION SYSTEM shutdown
41D	W2X STEER SOLENOID DISCONNECTED
	TRACTION SYSTEM shutdown, until cond. is cleared

SYSTEM FAULT CODES (ERRORS)

ERROR NO.	FAULT CONDITION & DISPLAYED TEXT
	Resulting Effect
42A	W2X LIFT SOLENOID DRIVER OVERHEATED
	LIFT SYSTEM, except lower, shutdown, until cond. clear
42B	W2X LIFT SOLENOID SHORTED TO SUPPLY
	LIFT SYSTEM, except lower, shutdown
42C	W2X LIFT SOLENOID SHORTED TO GROUND
	LIFT SYSTEM, except lower, shutdown
42D	W2X LIFT SOLENOID DISCONNECTED
	LIFT SYSTEM, except lower, shutdown, until cond. clear
43	TILT LIMIT REACHED
	SPEED limited until condition is cleared
44	TILT AND LIFT LIMITS REACHED
	SPEED limited and LIFT SYSTEM, except tilt back and lower, shutdown, until condition is cleared
45	LIFT SPEED LIMIT REACHED
	SPEED limited until condition is cleared
46	LIFT HEIGHT LIMIT REACHED
	LIFT SYSTEM, except lower, shutdown until cond. clear
47	IMPACT THRESHOLD EXCEEDED
	LIFT and TRACTION SYSTEM deration
48	<i>Not used</i>
49	LIFT MOTOR OVERHEATED
	LIFT SYSTEM, except lower, shutdown
50	<i>Not used</i>
51/ R	LEFT/RIGHT TRACTION MOTOR OVERHEATED
	TRACTION SYSTEM shutdown
52	<i>Not used</i>
53	LIFT CONTROL OVERHEATED
	LIFT SYSTEM, except lower, shutdown
54	<i>Not used</i>
55/ R	LEFT/RIGHT TRACTION CONTROL OVERHEATED
	TRACTION SYSTEM shutdown
56	STEER MOTOR BRUSH WEAR FAILURE
	TRACTION SYSTEM deration to 1 mph
57	LIFT MOTOR CURRENT NOT PRESENT
	LIFT SYSTEM shutdown
58	LIFT MOTOR CURRENT HIGH
	LIFT SYSTEM shutdown
59	STEER MOTOR CURRENT NOT PRESENT
	TOTAL shutdown

SYSTEM FAULT CODES (ERRORS)

ERROR NO.	FAULT CONDITION & DISPLAYED TEXT
	Resulting Effect
60	STEER MOTOR CURRENT HIGH
	TOTAL shutdown
61L/R	LEFT/RIGHT MOTOR BRUSH WEAR FAILURE
	SPEED limited
62L/R	LEFT/RIGHT TRACTION MOTOR FIELD CURRENT HIGH
	TRACTION SYSTEM shutdown
63L/R	LEFT/RIGHT TRACTION MOTOR FIELD CURRENT NOT PRESENT
	TRACTION SYSTEM shutdown
64L/R	LEFT/RIGHT TRACTION MOTOR ARMATURE HIGH
	TRACTION SYSTEM shutdown
65L/R	LEFT/RIGHT TRACTION MOTOR ARMATURE CURRENT NOT PRESENT
	TRACTION SYSTEM shutdown
66L/R	LEFT/RIGHT TRACTION - NO MOVEMENT DETECTED
	TRACTION SYSTEM shutdown
67L/R	LEFT/RIGHT DRIVE ROTATION DIRECTION FAILURE
	TRACTION SYSTEM shutdown
68L/R	LEFT/RIGHT BRAKE INOPERABLE OR NOT PROPERLY ADJUSTED
	TOTAL shutdown
69	SYSTEM CONTROL +5 VOLTAGE OUT OF RANGE
	TOTAL shutdown
70	SYSTEM CONTROL +15 VOLTAGE OUT OF RANGE
	TOTAL shutdown
71L/R	LEFT/RIGHT TRACTION CONTROL +5 VOLTAGE OUT OF RANGE
	TOTAL shutdown
72L/R	LEFT/RIGHT TRACTION CONTROL +15 VOLTAGE OUT OF RANGE
	TOTAL shutdown
73L/R	LEFT/RIGHT TRACTION CONTROL -15 VOLTAGE OUT OF RANGE
	TOTAL shutdown
74	LIFT CONTROL +5 VOLTAGE OUT OF RANGE
	TOTAL shutdown
75	LIFT CONTROL +15 VOLTAGE OUT OF RANGE
	TOTAL shutdown
76	LIFT CONTROL -15 VOLTAGE OUT OF RANGE
	TOTAL shutdown
77	SYSTEM CONTROL HARDWARE FAILURE
	TOTAL shutdown
78A	SYSTEM CONTROL SOFTWARE FAILURE
	TOTAL shutdown
78B	DOWNLOAD BACKUP SOFTWARE FAILURE
	TOTAL shutdown

SYSTEM FAULT CODES (ERRORS)

ERROR NO.	FAULT CONDITION & DISPLAYED TEXT
	Resulting Effect
78C	SYSTEM CONTROL CONFIGURATION FAILURE
	TOTAL shutdown
79	DISPLAY CONTROL CONFIGURATION FAILURE
	TOTAL shutdown
80	LIFT CUTOFF DUE TO LOW BATTERY STATE OF CHARGE
	LIFT system, except lower, shutdown
81	EACH BUTTON STUCK
	LIFT SYSTEM, except lower, shutdown
82	OPERATIONAL PARAMETERS INVALID
	TOTAL shutdown
83	<i>Not used</i>
84L/R	LEFT/RIGHT TRACTION MOTOR TEMPERATURE IMBALANCE EXCEEDED
	TRACTION SYSTEM shutdown
85	<i>Not used</i>
86L/R	LEFT/RIGHT TRACTION CONTROL TEMPERATURE IMBALANCE EXCEEDED
	TRACTION SYSTEM shutdown
87L/R	LEFT/RIGHT TRACTION DIODE FAILURE
	TRACTION SYSTEM shutdown
88	LIFT MOTOR CURRENT NOT PRESENT / DIODE FAILURE
	LIFT SYSTEM shutdown
89L/R	LEFT/RIGHT TRACTION CONTROL HARDWARE FAILURE
	TOTAL SYSTEM shutdown and open MAIN POWER CONTACTOR
90	LIFT/STEER CONTROL HARDWARE FAILURE
	TOTAL SYSTEM shutdown and open MAIN POWER CONTACTOR
91	STEER ENCODER FAILURE
	HARSH PLUG then TRACTION and STEER SYSTEM shutdown
92	STEER ROTATION FAILURE
	HARSH PLUG then TRACTION and STEER SYSTEM shutdown
93	KEYSWITCH CIRCUIT FAILURE
	DISPLAY MESSAGE until battery is disconnected
94	BOOST LIFT PUMP CONTACTOR WELDED
	Open MAIN POWER CONTACTOR



Providing VALUE Solutions

Schaeff Inc.
9655 Industrial Drive
Bridgeview, IL 60455, US

Tel: (708) 430 - 5301
Fax: (708) 430 - 5331

E-Mail: Mailbox@SchaeffInc.com
www.SchaeffInc.com

© Schaeff Inc. 10/03
Part Number 6840005
Printed in U.S.A.